

CFMA-1000AAC/50-BC-G

Old Type Designation: CF3C-1000E

Specifications	
Capacity C_{max} (nominal)	1000 pF
Voltage (Peak Test U_{pt} / Peak Working U_{pw})	50 kV / 30 kV
Capacity Tolerance	5%
Max. Current I_{max} at 13.56 MHz with	296 Arms
Conduction Cooling	50 W
Net Weight	6.4 kg

I_{max} at 25°C ambient and 125°C surface temp. for convection and conduction (50 W) cooling

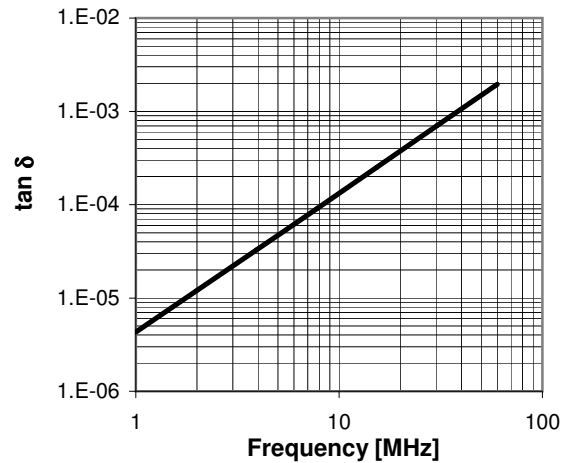
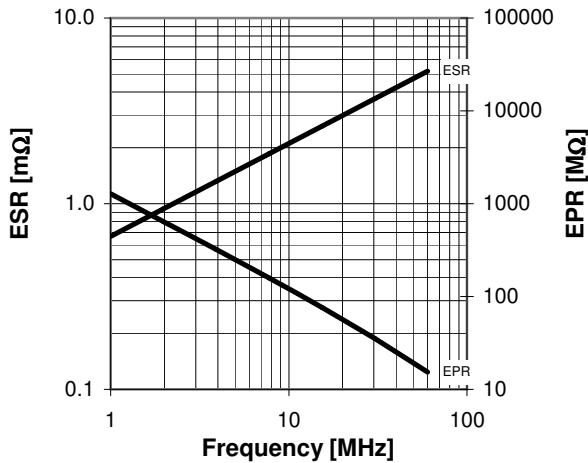
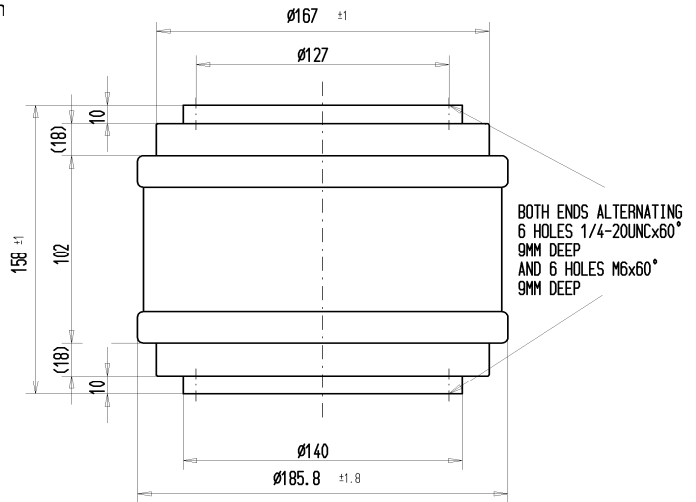
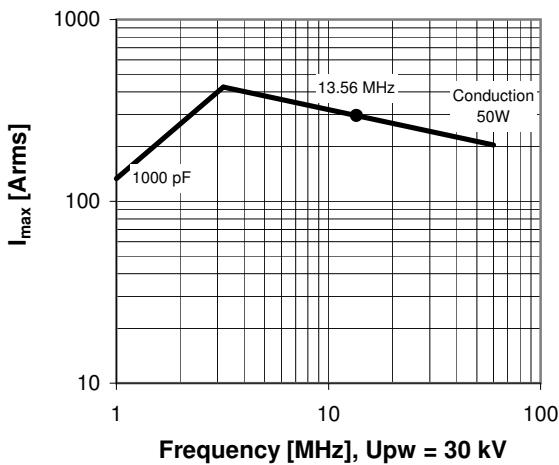

Special Features:

Capacity Tolerance 5%