

CFMA-2000AAC/35-BC-G

Old Type Designation: CF2C-2000E

Specifications	
Capacity C_{max} (nominal)	2000 pF
Voltage (Peak Test U_{pt} / Peak Working U_{pw})	35 kV / 21 kV
Capacity Tolerance	5%
Max. Current I_{max} at 13.56 MHz with	266 Arms
Conduction Cooling	50 W
Net Weight	7.2 kg

I_{max} at 25°C ambient and 125°C surface temp. for convection and conduction (50 W) cooling

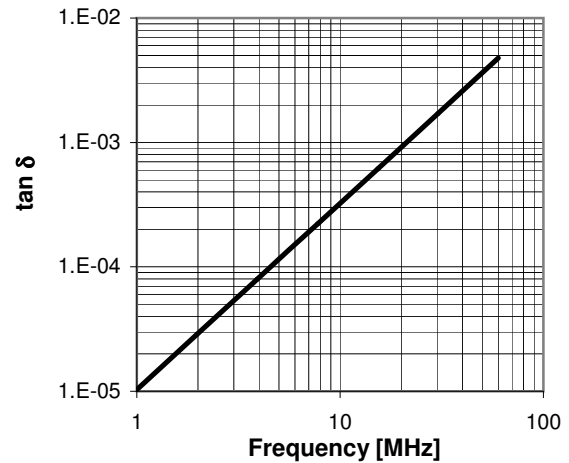
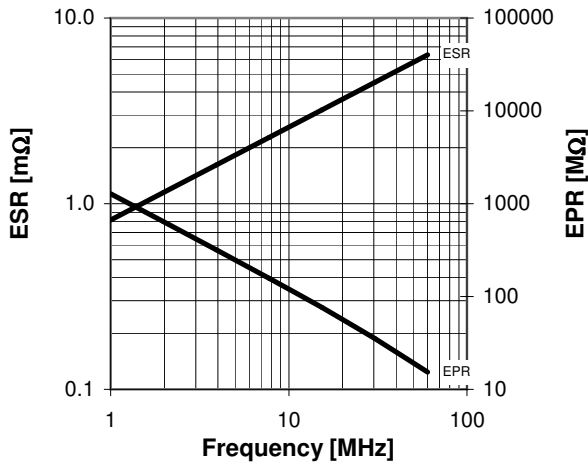
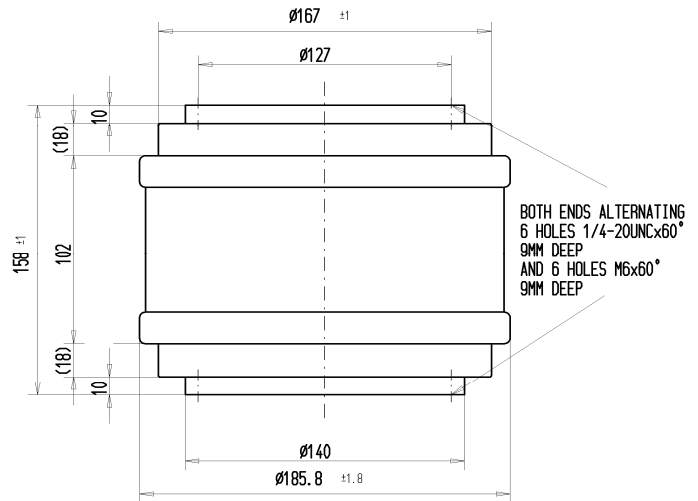
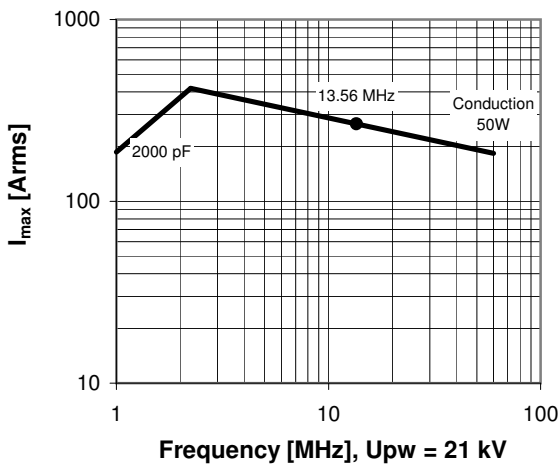

Special Features:
Capacity Tolerance 5%