

CFNC-50AAC/15-UH

Specifications	
Capacitance C_{max} (nominal)	50 pF
Voltage (Peak Test U_{pt} / Peak Working U_{pw})	15 kV / 9 kV
Capacitance Tolerance	10%
Max. Current I_{max} at 13.56 MHz with Conduction Cooling	27 Arms
Conduction Cooling	20 W
Net Weight	0.18 kg

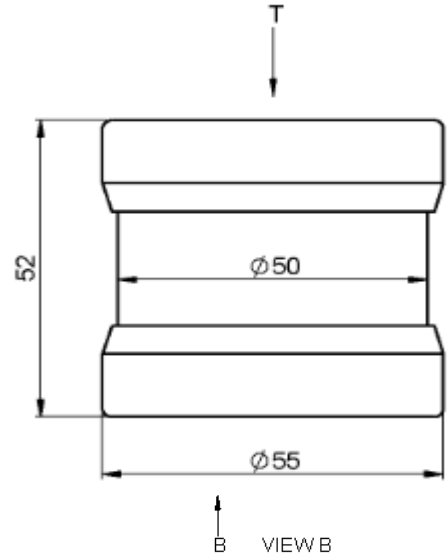

I_{max} at 25°C ambient and 125°C surface temp. for convection and conduction (20 W) cooling

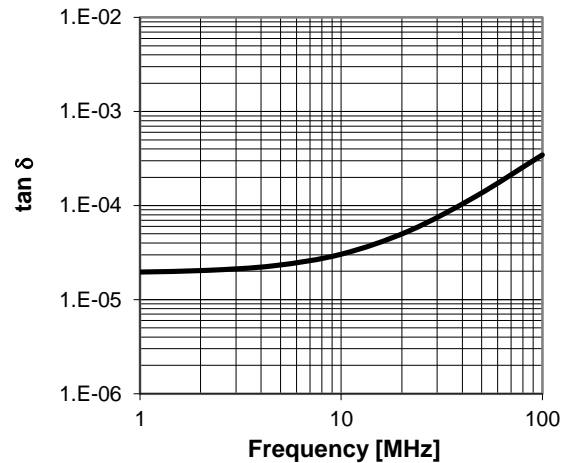
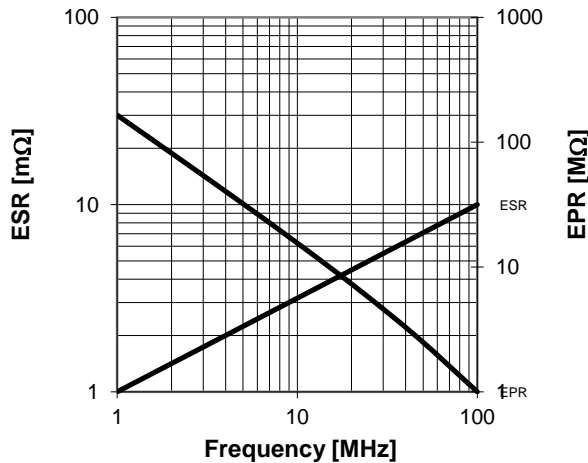
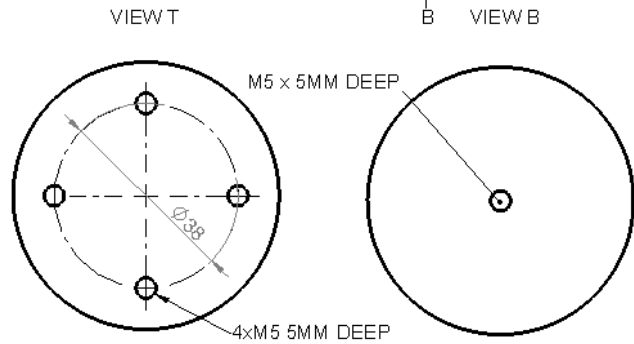
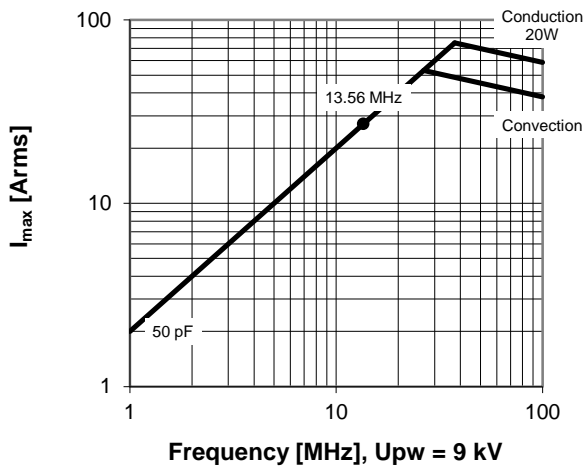

Special Features:
RoHS Compliant, Device under pressure

Subject to change without prior notice

Note: Technical information in Service Bulletin SB-52 must be considered