

# CMUN-60AC/15-X1-F

## Capacitor Specifications

Capacity $C_{max}$ (nominal)	60 pF
Capacity $C_{min}$ (nominal)	3 pF
Voltage (Peak Test $U_{pt}$ / Peak Working $U_{pw}$ )	15 kV / 9 kV
Ground to variable end insulation (Peak Test)	10 kV
Capacity Tolerance (linear Range)	1%
Max. Current $I_{max}$ at 13.56 MHz with	32 Arms
Conduction Cooling	15 W
Self Inductance	$\leq 8$ nH
Capacitance per 100 steps	2.5 pF
Net Weight	1.1 kg
Ground to variable end capacitance	$\leq 5$ pF

VIEW B

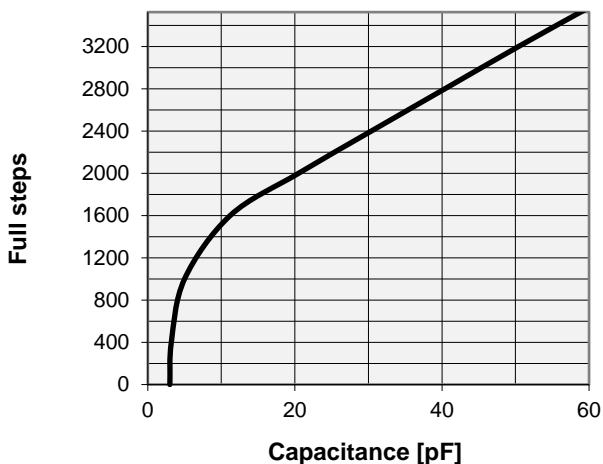
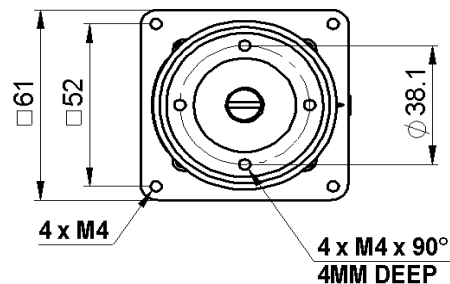

$I_{max}$  at 25°C ambient and 125°C surface temp. for convection and conduction (15 W) cooling

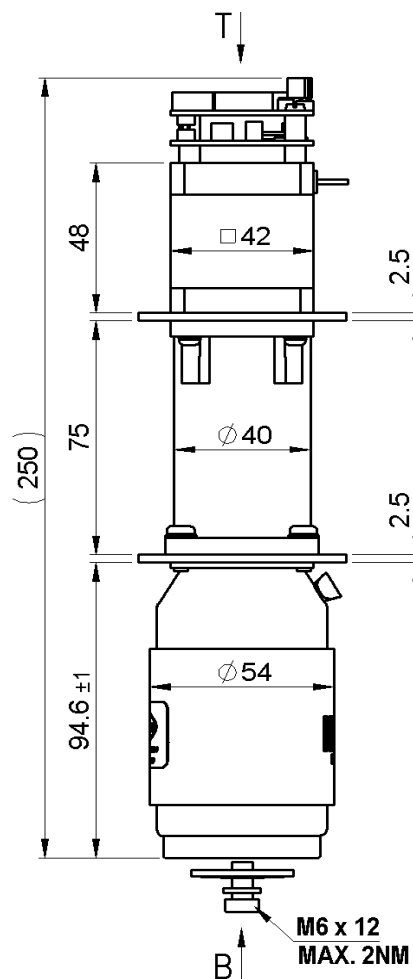
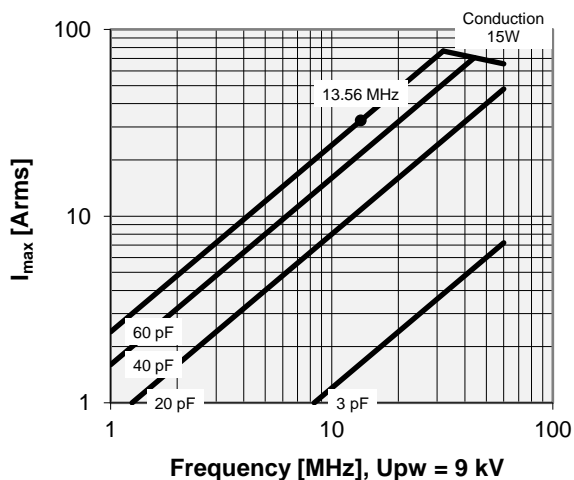

VIEW T

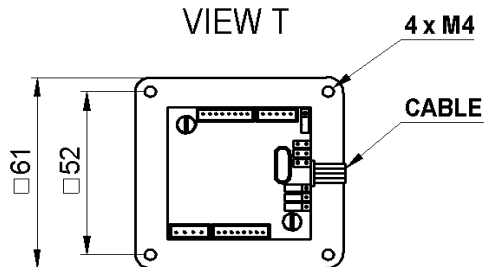

Note:

Technical information in Service Bulletin  
 SB-52 and SB-60 must be considered  
 Subject to change without prior notice

# CMUN-60AC/15-X1-F

Full steps	Nominal Capacitance [pF]	Tolerance
0	3.0	+/- 1pF
400	3.2	+/- 1pF
1000	5.0	+/- 1pF
1600	11.2	+/- 1pF
2000	20.5	+/- 1pF
2400	30.4	+/- 1pF
2800	40.4	+/- 1pF
3200	50.4	+/- 1pF
3570	60.0	+/- 1pF

Mechanical stop Cmin. at < 3 pF  
 Mechanical stop Cmax. at > 60 pF

Self inductance and resonance frequency

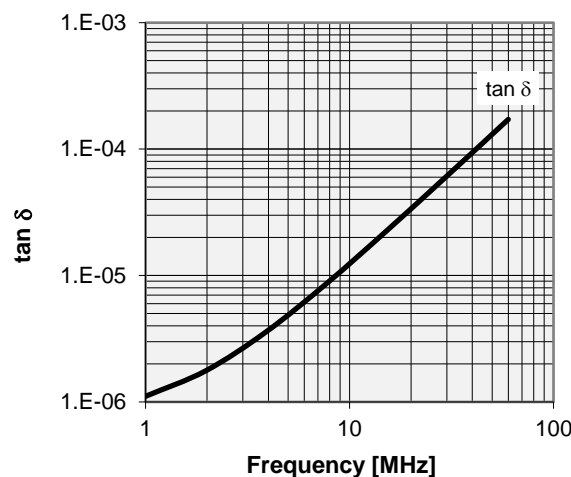
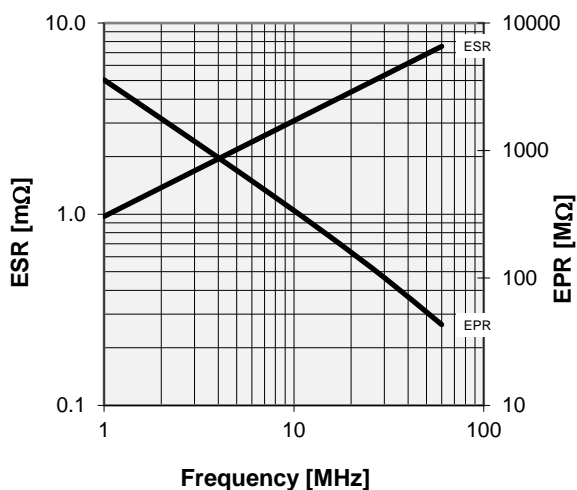
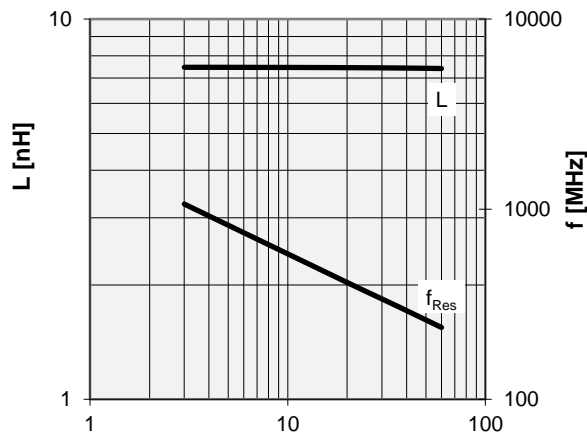

**General handling information for the integrated drive**

When installing or removing the integrated drive, extreme care must be taken to avoid damage to the body of the integrated drive. Although the integrated drive look very rugged from the outside it must be remembered that, due to the brazing process used to join ceramic and copper, the copper is in a soft, annealed condition and is therefore highly susceptible to mechanical deformation. For this reason, any rough handling, like machining of the flanges, must be avoided. Use existing threads and holes for fixation.

**General installation information for the integrated drive**

For all integrated drives we recommend that one side be mounted non-rigid to prevent excessive thermomechanical and external forces from acting on the capacitor.

# CMUN-60AC/15-X1-F

Drive Specification	
Type	ID-400
Tuning speed (end to end)	<3 s
Backlash	≤ 2 steps
Operation mode	Bipolar
Nr. of phases	2
Current per phase	2.8 A
Supply voltage (DC)	24 V
Full step angle	1.8°
Motor frame size	42 mm

Layout of the microcontroller PCB

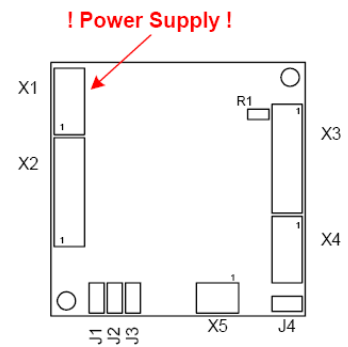

X1 Power supply			
Pin 1	VCC	+7...28 V	
Pin 2	VCC	+7...28 V	
Pin 3	GND	+0 V	
Pin 4	GND	+0 V	

X2 Additional I/O - Connector			
Pin 1	Left limit switch	-	
Pin 2	Right limit switch	-	
Pin 3	GND	+0 V	
Pin 4	GPO (General purpose output)	-	
Pin 5	VCC	+7...28 V	
Pin 6	GND	+0 V	
Pin 7	GPI (General purpose input)	-	
Pin 8	DC output	+5 V(max. 20mA)	

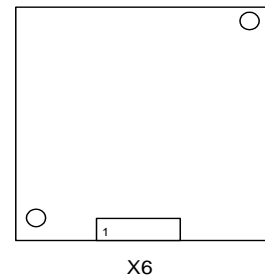

X3 Interface to motor driver - Connector				
Interface Typ	RS-232	R-485	Step / Direction	CW / CCW
Pin 1	TxD	+0V (GND)	+0V (GND)	+0V (GND)
Pin 2	RxD	+0V (GND)	+0V (GND)	+0V (GND)
Pin 3	+0V (GND)	A (+)	+0V (GND)	+0V (GND)
Pin 4	+0V (GND)	B (-)	+0V (GND)	+0V (GND)
Pin 5	+0V (GND)	+0V (GND)	Step	+0V (GND)
Pin 6	+0V (GND)	+0V (GND)	+0V (GND)	CW
Pin 7	+0V (GND)	+0V (GND)	Direction	+0V (GND)
Pin 8	+0V (GND)	+0V (GND)	+0V (GND)	CCW

X6 Additional I/O - Connector	
Pin1	OA1 (motor / red)
Pin2	OA2 (motor / blue)
Pin3	OB1 (motor / green)
Pin4	OB2 (motor / black)

X4 not used; X5 not used

Note:

Technical information in Service Bulletin SB-52 and SB-60 must be considered  
Subject to change without prior notice