

CVDU-500AC/5-CGD

Old Type Designation: CV05C-500B

Specifications

Capacity C_{max} (nominal)	500 pF
Capacity C_{min} (nominal)	5.6 pF
Voltage (Peak Test U_{pt} / Peak Working U_{pw})	5 kV / 3 kV
Capacity Tolerance (linear Range)	10%
Max. Current I_{max} at 13.56 MHz with	63 Arms
Conduction Cooling	15 W
Self Inductance	≤ 7 nH
Capacitance per turn	37.8 pF/turn
Torque	≤ 0.15 Nm
Net Weight	0.4 kg

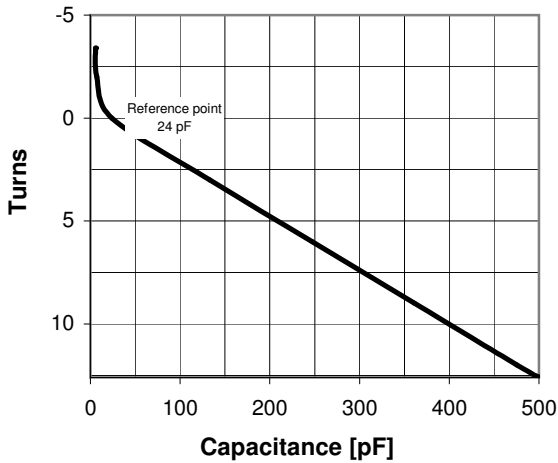
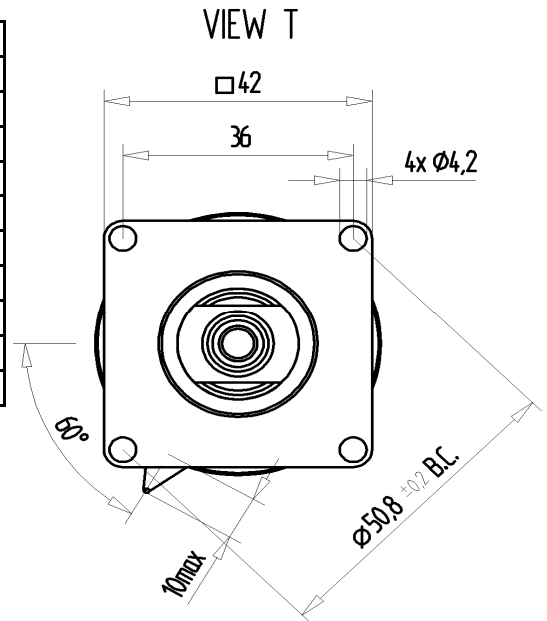

I_{max} at 25°C ambient and 125°C surface temp. for convection and conduction (15 W) cooling

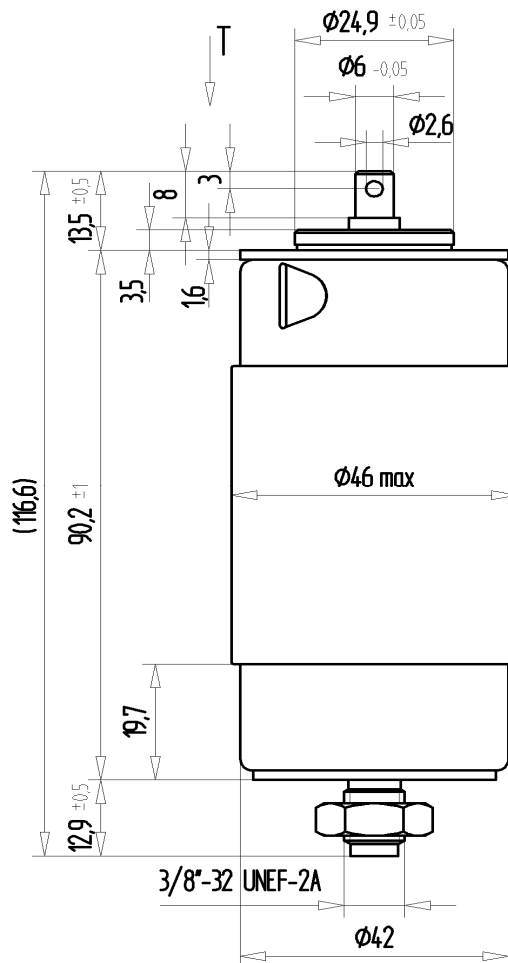
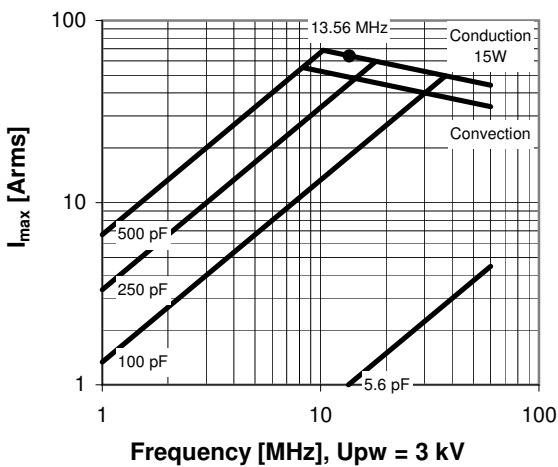

Subject to change without prior notice

Note: Technical information in Service Bulletin SB-52 must be considered



Technology with Passion

www.comet-pct.com

CVDU-500AC/5-CGD

Old Type Designation: CV05C-500B

Turns	Nominal Capacitance [pF]	Tolerance
-3.4	5.6	10%
-2.0	7.0	10%
0.0	24.0	0%
3.0	133.1	10%
6.0	247.2	10%
9.0	361.3	10%
12.0	475.4	10%
12.6	500.0	10%

Mechanical stop at < 5.6 pF at ~ -6.8 turns
 Mechanical stop at > 500 pF at ~ 12.9 turns

Self inductance and resonance frequency

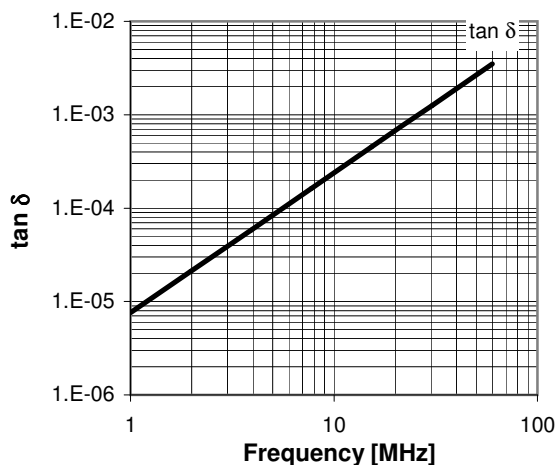
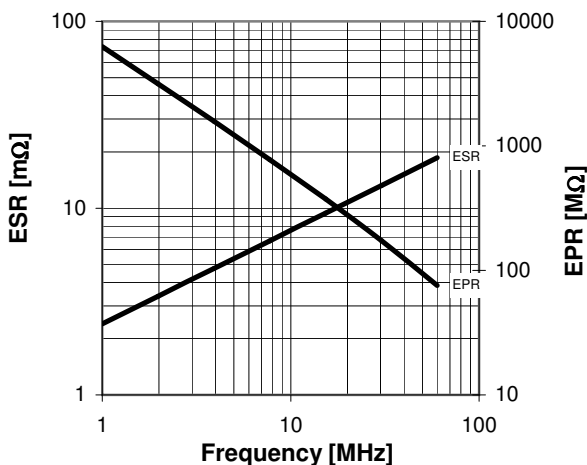
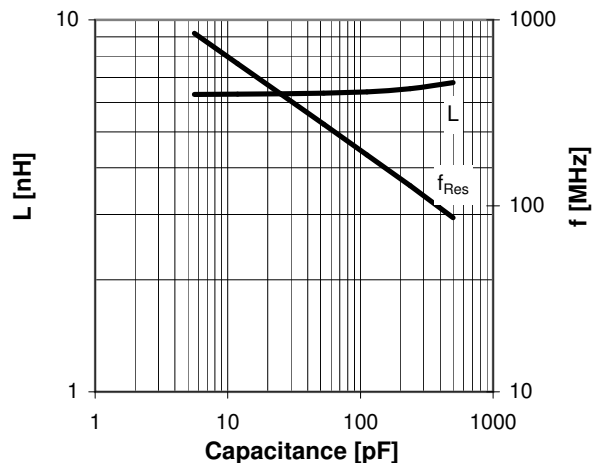

Subject to change without prior notice

Note: Technical information in Service Bulletin
 SB-52 must be considered

Issue: 27-Jan-2012
 Replaces: 04-Apr-2000