

Motorized Capacitor

Electrical Installation of ID-1200



Document Information

AuthorsO. Lehmann / A. Renggli / T. Fenske
DocumentSB-64-02.doc
Created on.....24-Jan-2013
Revision.....02
Comment.....Revised version

Document history

Doc. Rev.	Date	Author(s)	Change(s)	Status
1.0	2007-03-30	O. Lehmann	Initial document	released
1.1	2010-06-25	A. Renggli	Various additions	internal
02	2014-01-24	W. Bigler / T. Fenske	Reviewed with minor modifications / configuration section added	released

Table of Contents

Overview of Service Bulletins for Integrated Drives (ID)	4
1 Overview Driver Unit ID – 1200	5
2 Stepping driver controller Interface for EXPERT	6
2.1 Communication Interfaces	6
2.2 Block-diagram of the stepping motor driver	6
3 Controller Board ID Connections for ID - 1200	7
3.1 Resistor array R1	10
3.2 Activity LED	10
3.3 Operating ratings for ID-1200	10
4 Revision history	11

Overview of Service Bulletins for Integrated Drives (ID)

- SB-60** Overview of Integrated Drives
- General product description
 - Drive unit product lines and related capacitor series
 - Function levels and configurations
 - Description of module components
 - Technical specifications
 - Overview of the product range
 - Type designation
- SB-61** Drive Unit
- Drive unit product lines
 - Description of the drive unit components
- SB-62** Introduction to Stepping Motors
- Principal function of stepper motors
 - Control system of the drive unit
- SB-63** Electrical Installation ID-400
- Stepping driver control signals and connections for EXPERT ID
- SB-64** Electrical Installation ID-1200
- Stepping driver control signals and connections for EXPERT ID
- SB-65** Electrical Installation ID-2800
- Stepping driver control signals and connections for EXPERT ID
- SB-66** Electrical Installation ID-5400
- Stepping driver control signals and connections for EXPERT ID
- SB-67** Step/Direction; Clockwise / Counter clockwise (CW/CCW) Interface
- Stepping driver signals
 - Stepping driver timing diagram
- SB-68** Software Protocol Interface RS-232
- Specification of the interface
 - Frame structure
 - Communication protocol between the ID and the host system
- SB-69** Software Protocol Interface RS-485
- Specification
 - Frame structure
 - Communication protocol between the ID and the host system
- SB-72** Safety Aspects of Integrated Drives
- Capacitor
 - Electrical Insulation between ID and Capacitor

DATA SHEETS are available for each Integrated Drive

1 Overview Driver Unit ID – 1200

Picture 1 show and explain the components of the driver unit ID – 1200.

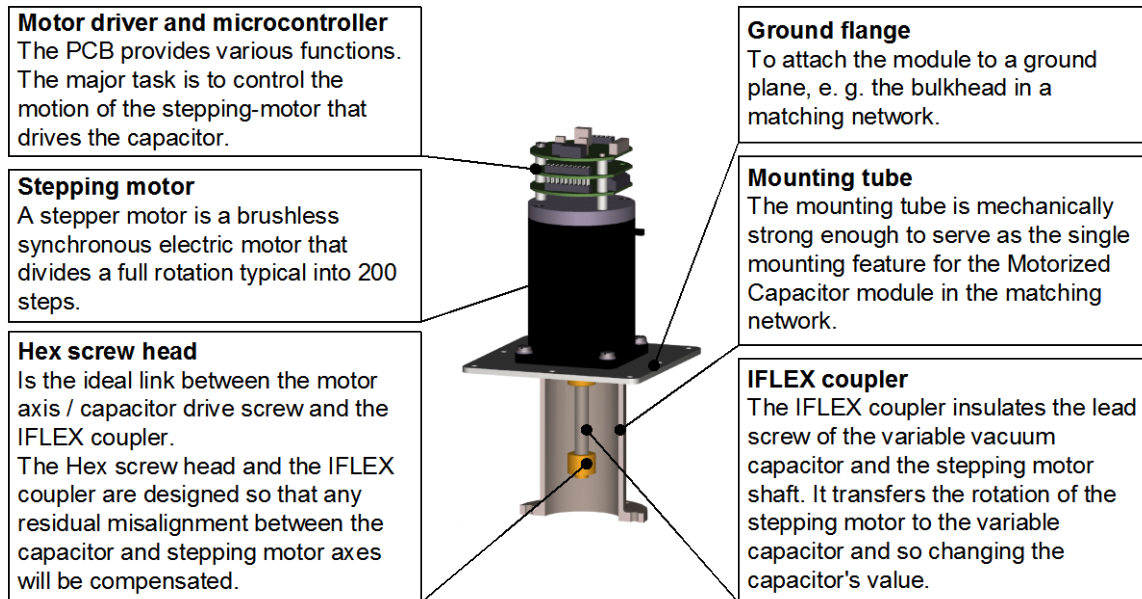

Fig. 1: Components of the driver unit ID - 1200

2 Stepping driver controller Interface for EXPERT

2.1 Communication Interfaces

The communication interface is the interface between the controller unit (e.g. PC) and the driver board. Specifications of the COMET proprietary communication protocols are available for RS-232 and RS-485 interfaces.

2.2 Block-diagram of the stepping motor driver

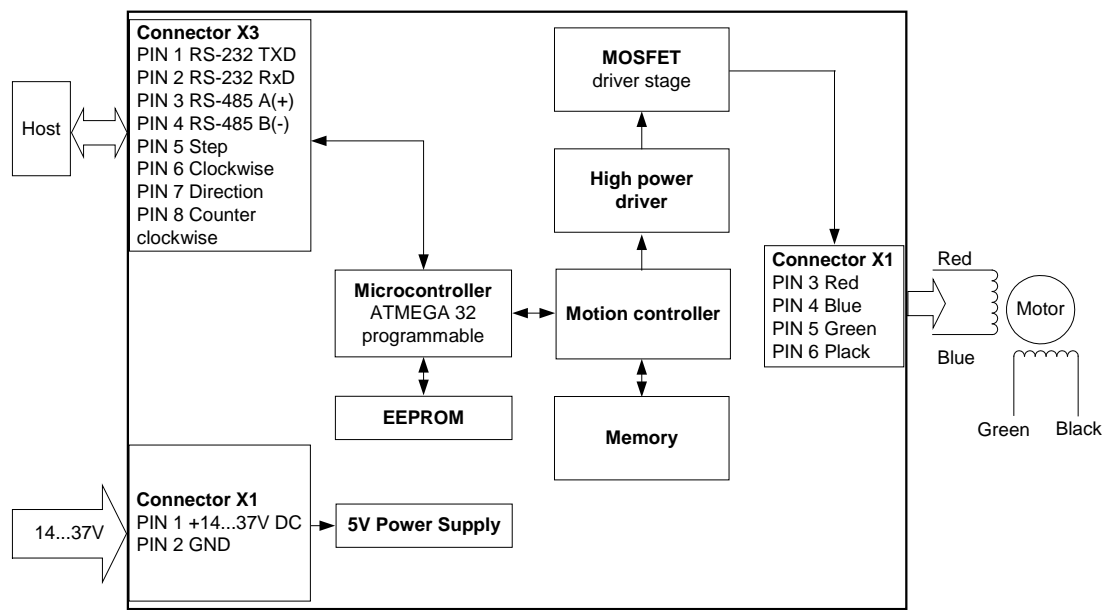

Fig. 2: Terminology of driver and motor control signals

3 Controller Board ID Connections for ID - 1200

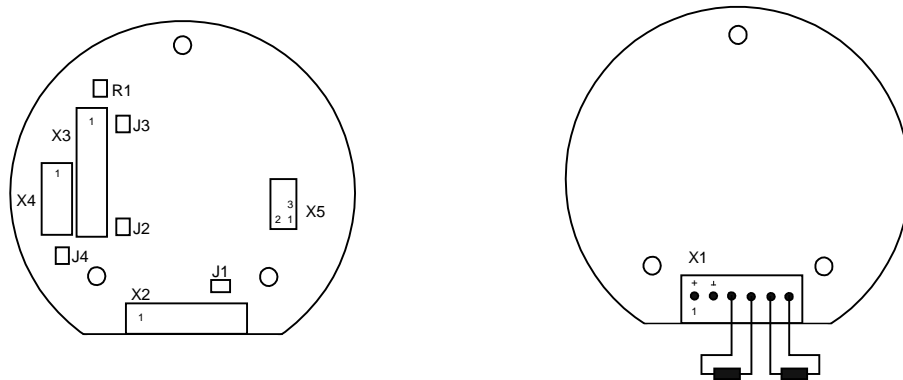

Fig. 3: Layout of the controller board ID - 1200

The left layout in Fig. 3 shows the top board, the right layout shows the bottom board.

X1 Connector - Power supply for the ID - 1200

Power is provided to the PCB through this connector. The product will be shipped with a female connector that is compatible with the X1 connector on the board and with the required wires.

Pin	Function	Colour
1	+ 14 ... 37 V DC	red
2	GND	black
3	OA1 (motor)	red
4	OA2 (motor)	blue
5	OB1 (motor)	green
6	OB2 (motor)	black

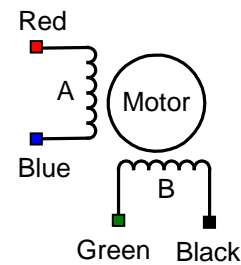

Fig. 4: Pin layout of connector X1 for the ID-1200

!! The motor must never be unplugged during operation!!

The ID-1200 incorporates a linear voltage regulator to generate the 5V supply voltage for the digital components of the module. Therefore only one supply voltage is needed for the module. The power supply voltage can be +7...+37 V DC. A higher voltage gives higher motor dynamics. Please note that there is no protection against reverse polarity or over voltage. The power supply should be designed so that it supplies the nominal motor voltage at the desired maximum motor power. In no case shall the supply value exceed the upper / lower voltage limit. To ensure reliable operation of the unit, the power supply has to have a sufficient output capacitor and the supply cables should be of low resistance so that the chopper operation does not lead to an increase in power supply ripple. Power supply ripple due to the chopper operation should be kept to a maximum of 200-300mV. This also is important in order to make the user's application compatible to any applicable EMC guidelines.

Therefore we recommend that:

- power supply cables be kept as short as possible
- large diameter power supply cables be used
- If the distance to the power supply is more than 2 - 6m) a robust 470µF or larger additional filtering capacitor be located near to the motor driver unit.

X2 Connector - Additional I/O

The limit switch inputs are equipped with internal pull-up resistors, so they have to be connected to GND via normally closed switches. They are used as an absolute position reference for homing and to set a hardware limit for the motion range¹. The general purpose output is an open collector output for a maximum current of 100mA. A freewheeling diode is also included so that for example a relay or a coil can be connected directly. Please note that the freewheeling diode is connected to the supply voltage and not to +5V, so when using a relay that is connected to +5V a freewheeling diode must be connected externally. The general purpose input is used as a digital TTL input. By connecting pin 7 to a high voltage state (3.5 – 5.5Volts) the ID will do a reference drive. The pin assignment of this connector is as follows:

Pin	Function
1	Left limit switch
2	Right limit switch
3	GND
4	General purpose output
5	VDD (same as connector X1, pin1)
6	GND
7	General purpose input
8	+ 5 V DC output (max. 20 mA)

Fig. 5: Pin layout of connector X2

When pin 7 is connected to +5V DC the ID - 1200 will start with a reference drive.

X3 Connector - Serial interface

This connector provides access to and from the PCB via serial interfaces, i. e. RS-232 and RS-485. Jumper J1 is used to select the proper serial interface port.

Important: If the Step/Direction Interface not in use, pin 5 and 7 have to be connected to GND!

¹ This function is only available on request





Pin	Interface			
	EXPERT-1	EXPERT-2	EXPERT-3	EXPERT-3
	RS-232	RS-485	Step / Direction	CW / CCW
1	TxD	+0V (GND)	+0V (GND)	+0V (GND)
2	RxD	+0V (GND)	+0V (GND)	+0V (GND)
3	+0V (GND)	A (+)	+0V (GND)	+0V (GND)
4	+0V (GND)	B (-)	+0V (GND)	+0V (GND)
5	+0V (GND)	+0V (GND)	Step 	+0V (GND)
6	+0V (GND)	+0V (GND)	+0V (GND)	Clockwise 
7	+0V (GND)	+0V (GND)	Direction 	+0V (GND)
8	+0V (GND)	+0V (GND)	+0V (GND)	Counter Clockwise 

Fig. 6: Pin layout of connector X3

X4 Connector is not used and has to be unplugged.

X5 Connector – ISP programmer

The 6-way (2x3) header on the module is the connector for an Atmel ISP programmer which can be used to program the CPU directly. This is to be done by COMET AG only. The ISP connector is for COMET use only. Always leave this connector open. The only purpose where this connector can be used by the user is to reset the module to factory defaults. To do this, first power off the module. Then connect a jumper to link pins 1 and 3. After this the power can be restored. The activity LED now flashes very quickly. Disconnect the power supply again and remove the jumper. When the module is switched on again, all settings will be restored to their factory defaults.

Jumpers J1, J2, J3 and J4

These jumpers have the following functionality:

- J1: Interface selection. This jumper selects which interface is to be used when the module starts up. When this jumper is open it will be RS232, and when it is closed it will be RS485.
- J2: CAN/RS485 termination. Close this jumper to terminate the CAN/RS485 bus with a 120 Ohms resistor.
- J3: Step/Direction termination. Close jumper to terminate the step-signal with a 120 Ohms resistor.
- J4: Step/Direction termination. Close jumper to terminate the direction-signal with a 120 Ohms resistor.

	RS-232	RS-485	Step / Direction	CW / CCW
Jumper - J1	Open	Close	N/A	N/A
Jumper – J2	Open	Open	N/A	N/A
Jumper – J3	Close	Close	Open	Open
Jumper – J4	Close	Close	Open	Open

Fig. 7: Jumper position

3.1 Resistor array R1

This resistor array allows the use of non-differential Step/Direction signals. This voltage divider generates the half potential of the Step/Direction supply voltage to the negative differential inputs. If you use differential input signals please remove this resistor array!

3.2 Activity LED

The controller board of the ID-1200 is equipped with a red LED. During normal operation this LED flashes. After resetting the configuration EEPROM it may take a few seconds before the LED starts flashing again. When the operating system is being downloaded to the module the LED emits a constant light.

3.3 Operating ratings for ID-1200

Sympol	Parameter	Min	Typ	Max	Unit
V_S	Power supply voltage für operation	14	15...36	37	V
I_{COIL}	Motor coil current for sine wave peak (chopper regulated, adjustable via software)	0	2.8...7	7.1	A
I_{MC}	Continuous motor current (RMS)	0	2...5	5.0	A
I_S	Power supply current		2...3	7.1	A
U_{+5V}	+5V output (max. 20mA)	4.8	5.0	5.2	V
V_{INPROT}	Input voltage for StopL, StopR, GPI (internal protection, DC)	-24	0 .. 5	24	V
V_{ANA}	GPI analog measurement range (range switchable)		0 ... 5 0 ... 10		V
V_{STOPLO}	StopL, StopR low level input		0	0.9	V
V_{STOPHI}	StopL, StopR high level input (integrated 10k pullup to +5V)	1.9	5		V
T_{ENV}	Environment temperature at rated current (no forced cooling required)	-40		45	°C
T_{ENV}	Environment temperature at 80% of rated current or 50% duty cycle (no forced cooling required)	-40		60	°C

Fig. 8: Operation ratings for the ID - 1200

4 Revision history

Changes from document SB-63 V.1.1 to SB-63 Rev. 02:

Section	Description of change
General	Updated document to cover firmware version V.2.X in addition to V.1.X
3.3	Updated Operating conditions for ID-1200