

X-Cap™ SlimLine (A Variable Gas Capacitor)

1. Introduction

In 1997 COMET TECHNIK AG presented the first series of X-CAP™ to the market. It was an answer to the market request to fill the gap between the older, less reliable air vain capacitor and the more expensive vacuum capacitor for the rf-power range from 3 to 5 kW.

With continued improvements and based on the existing X-Cap™ the new X-CAP™ SlimLine series was designed for higher power and is available in quantities since 2000. It is focusing also on those applications which initially were designed for air caps and which now shall be upgraded to higher power levels. Having better performance, higher flexibility in design and more attractive outline, the SlimLine series is able to replace the air caps in many cases.

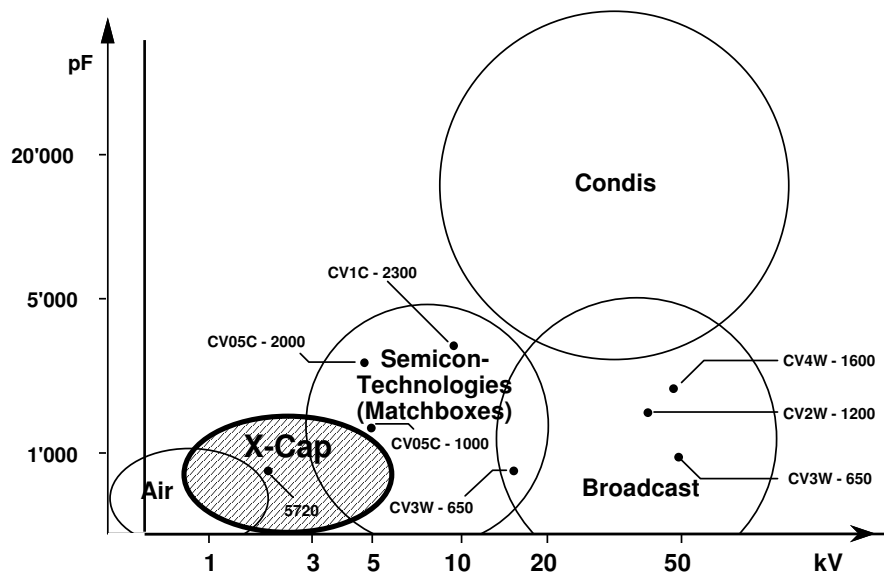

The application field of X-CAP™ is where today standard air capacitors are used but assuring better performance. Due to the hermetically closed design, it is particularly suitable for rugged and dirty environments (dust, oil, vapors ...). This device will work for years without the need of any maintenance work. It is obvious, that the X-CAP™ can fill the gap between the air and vacuum capacitor and even the lower end of the vacuum capacitor applications.

2. History

Since the presentation of the first X-CAP™ a series of improvements were carried out, leading to an attractive product at moderate price.

- New electrode shapes to change C_{min} -> C_{max} in 1/2 turn (previously 1/4 turn)
- Abrasion proof shaft material and increased shaft diameter 5.0 mm → 1/4"
- Single flat on shaft replaced by 90° double flats for reliable connection to driving unit
- Bigger mounting threads (M4 → M5) on each side of variable electrodes
- Aligned orientation of connecting and mounting threads
- Improved shape of insulators and new plastic material (red) for operating at higher voltage
- New outline was designed, smaller in diameter but longer shape
- Considerable increase of current and voltage capabilities
- Optionally available with ball bearing for sideload up to 50N
- Insulators also available with non flammable, black plastic insulator (UL 94)

3. Technical Data

Description

Variable high voltage inert gas capacitor for various applications in the frequency range from audio to 30 MHz.

Today, the X-CAP™ SlimLine series includes the following 4 standard versions which optionally are available also with ball bearing at unchanged outline:

Type 2004 (Type 1965)	Capacitance range	Peak test voltage
CVXC-380... (XS 55-380)	55 - 380 pF	13 kV
CVXC-550... (XS 60-550)	60 - 550 pF	11 kV
CVXC-850... (XS 65-850)	65 - 850 pF	7 kV
CVXC-1600... (XS 70-	70 - 1600 pF	3 kV

Electrical Data

Parameter	XS 55 - 380	XS 60 - 550	XS 65 - 850	XS 70 - 1600
Capacitance range C_{max} -5% to 10% C_{min} 0% to -25%	55 - 380 pF	60 - 550 pF	65 - 850 pF	70 - 1600 pF
Test voltage	13 kV _n	11 kV _n	7 kV _n	3 kV _n
Working voltage	8.5 kV _n	7.0 kV _n	4.0 kV _n	1.80 kV _n
Current at 13.56 MHz / 25°C	33 A _{rms}	33 A _{rms}	33 A _{rms}	33 A _{rms}
Series inductance	19 nH	19 nH	19 nH	19 nH

Mechanical Data

Net weight	610 gr.	625 gr.	650 gr.	670 gr.
------------	---------	---------	---------	---------

turns for minimum to maximum capacitance	1/2 turn (180°), endless movement
shaft diameter	6.35 mm (1/4"), 90° double flat on top
maximum torque	0.2 Nm (= 2.05 cmkg or 1.77 inlb)
sideload standard SlimLine	keep at minimum level for best life time
sideload for K-type SlimLine family (with ball bearing)	50 N
maximum body temperature storage	-30 to + 100° C
operating	-10 to + 100° C
mounting position	any

Notes: It is important to use all provided mounting holes/threads of the insulator; this in order to make sure, that the imbedded brass bushings are connected to a well defined electrical potential. If connection or mounting will not require the use of all mounting holes, at least one M5 screw (delivered with the capacitor) should be inserted and tightened.

4. Outlines

For setting the X-Cap™ to C_{max} , the edge between the two 90° flats of the tip of the driving shaft must point to the color dot (see above drawings).

For some customized versions with single flat, in the C_{max} position the flat has to face to the color dot.

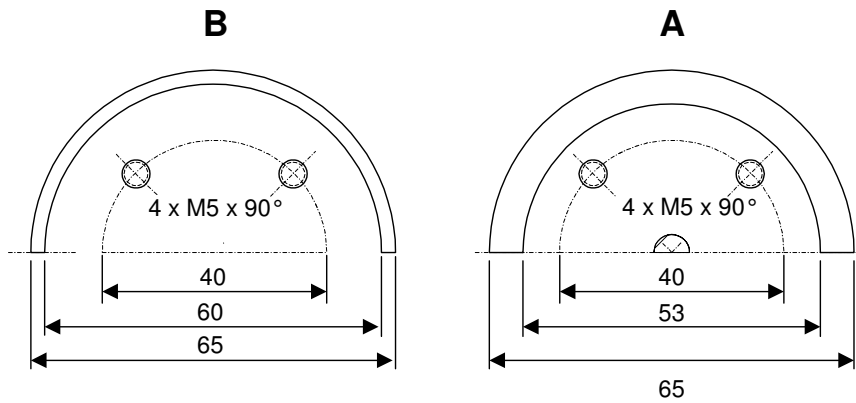
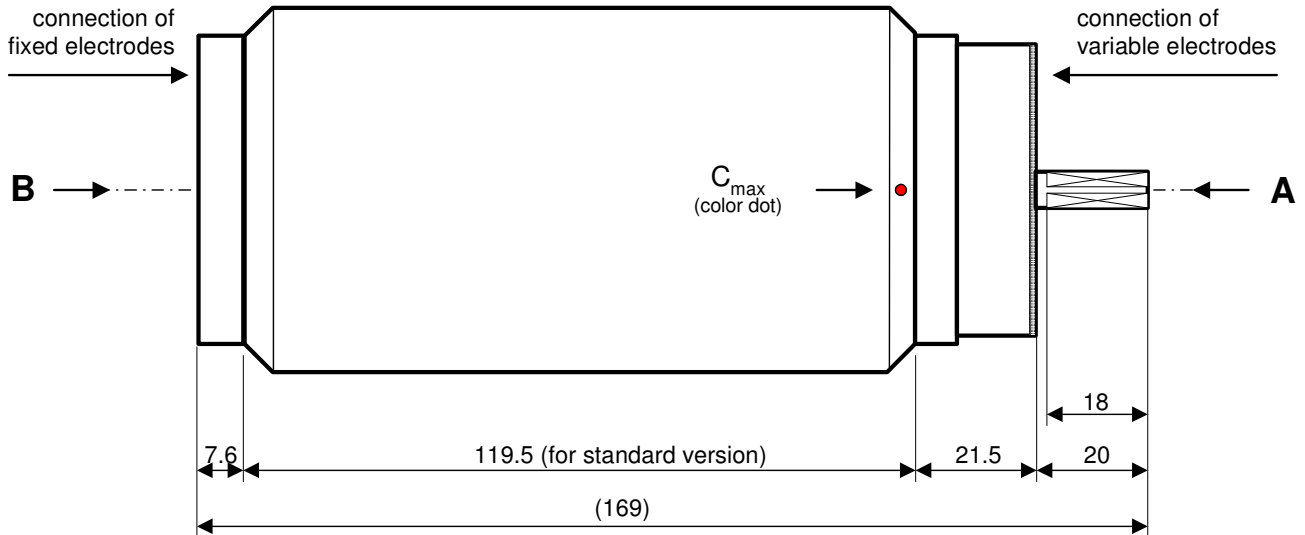

5. Parameters

5.1 Capacitance

The indicated capacitance values for X-Cap™ standard and SlimLine were measured at a frequency of 10 kHz. The ratio between capacitance change and rotation angle of the driving shaft is linear. Due to the internal series inductance and ohmic resistance, the externally measured capacitance will become non-linear above about 3 to 5 MHz depending of the applied frequency. The following diagrams show the capacitance value over the frequency range, each for the shaft positions at C_{min} ($\alpha=0^\circ$), $1/2 C_{max}$ ($\alpha=90^\circ$) and at C_{max} ($\alpha=180^\circ$).

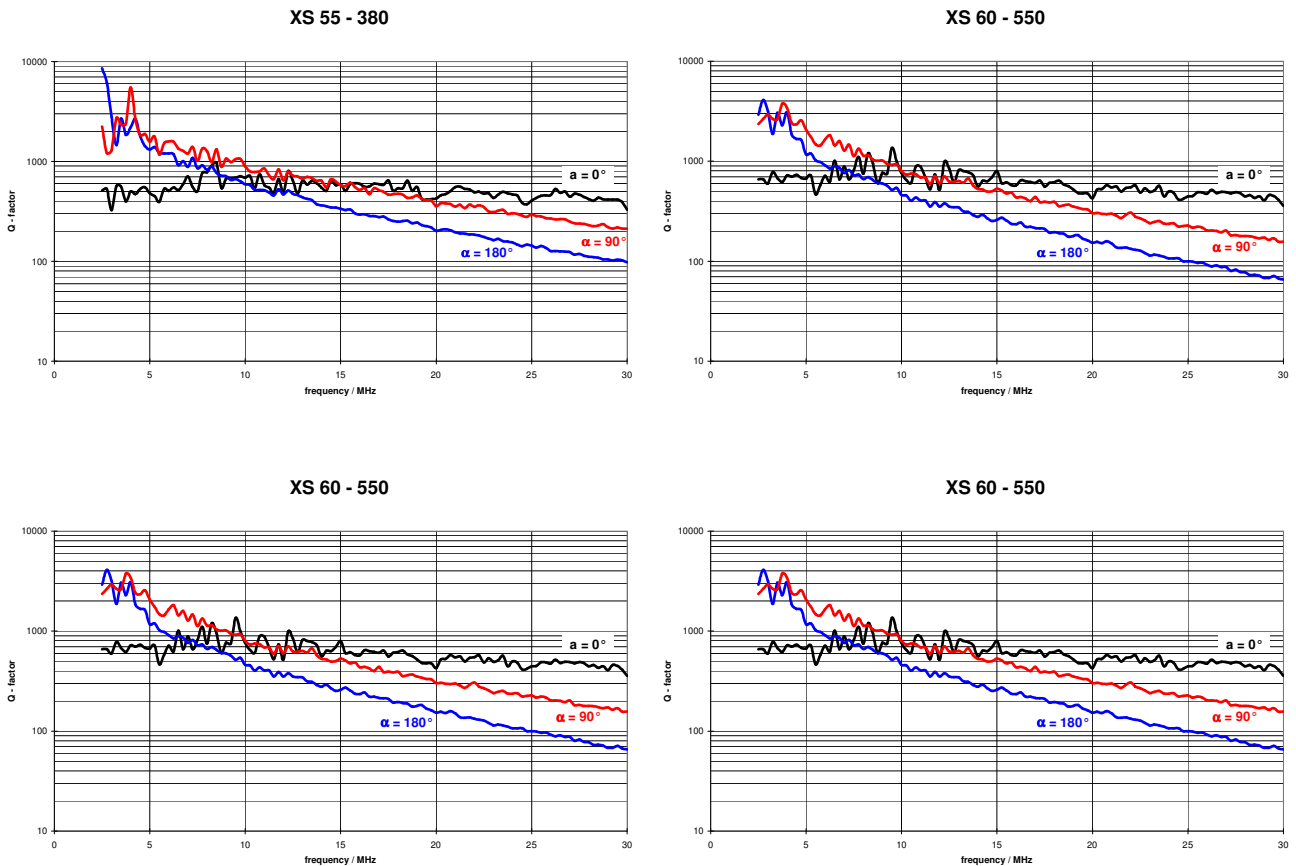

The capacitance C_{ext} at the connecting plates and at a given frequency can be calculated using the following formula:

$$C_{ext} = \frac{C_{int}}{1 - \omega^2 \cdot C_{int} \cdot L_{int}}$$

The measurements were made by means of a Hewlett Packard network analyzer with a source impedance of $(50 + j0) \Omega$. For the frequency range of 30 kHz up to 300 MHz the complex S11-parameters have been recorded and then arithmetically transformed into the

Z-plane. R and jX -values were then used to determine capacitance, resonance frequency and loss angle.
 (loss angle = Q- factor⁻¹).

These measurements were also taken to determine the series inductance of the basic types of X-CAP™. The measured resonance frequency and the external capacitance at 10 kHz lead to the specified inductance.

5.2 Q-Factor

The Q-factor is inversely proportional to the resistivity, the capacity of the capacitor and the frequency used. Higher capacitances, resistivity and frequencies will therefore lead to lower Q-factors. As described under 3.1, the loss angles of all four X-CAP™ versions of the standard family were computed, based on actual measurements of the devices. The following graphics show the Q-factors, depending on the set capacitance. The three graphs of each figure show the Q-factor for the positions C_{min} (□=0°), 1/2 (C_{max} + C_{min}) (□=90°) and C_{max} (□=180°).

XS 55 - 380

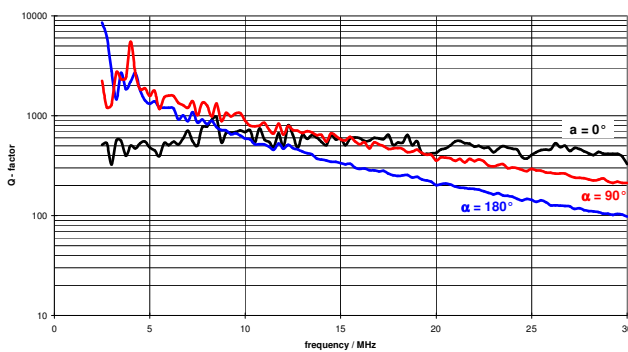

XS 60 - 550

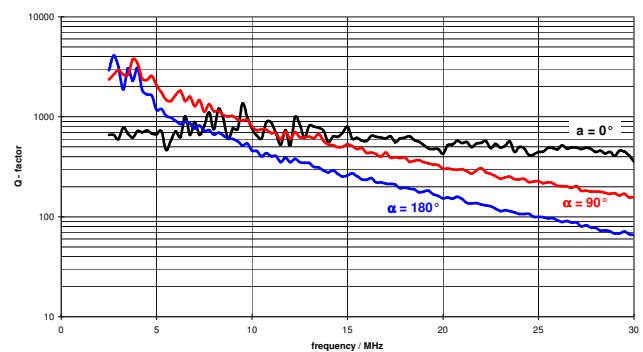

XS 65 - 850

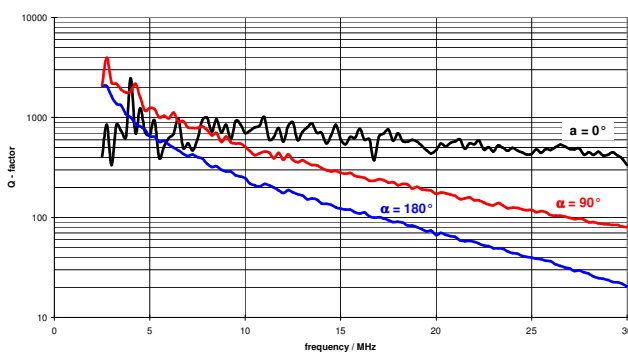

XS 70 - 1600

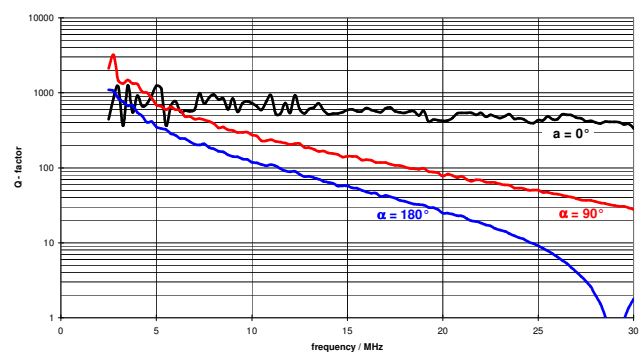

5.3 Peak Working Voltage

The peak working voltage depends mainly on 3 factors: The minimum distance between the internal electrodes, the properties of the dielectric between these electrodes and the distance between the external connections. As the almost identical housing length has been used for the four standard versions, the electrodes of the 1600 pF type are packed more densely than those of the 380 pF version leading therefore to different hold-off voltages (see table on page 2). In production, the 50/60 Hz - test peak voltage has to be at least 1.6 times higher than the specified voltage capability at high frequency. Towards higher C-values this factor is higher because of the increasing number of electrodes and spacing rings and the more and more important impact of the thickness tolerance of these parts. For yield reasons the factor U_{pt} / U_{pw} is higher for higher capacitance values than for the lower ones.

5.4 Current Capabilities

Due to the skin effect, not the entire section of the electrodes will contribute to current conduction and to low series resistance. The electrically charged capacitor will therefore generate loss power depending on the electrical current, the position of the variable electrodes and the set frequency. The ohmic series resistance of the device is strongly depending on the relative position of the electrodes. On top of this, at C_{max} the gas can freely circulate in one half of the volume and transport the internal heat by convection to the body surface. Due to maximum common surface at C_{max} we have also best exchange of thermal energy between the inner variable electrodes and the outer fixed ones. In this position the current capability is best. At C_{min} the convection and radiation effects are reduced and therefore lead to lower current capabilities which in itself is no problem since at C_{min} XC is max and therefore allow lower current anyhow.

The following figures show the current limits depending on the frequency and the position of the electrodes. The ambient temperature is 21 °C, the capacitors exposed to free airflow.

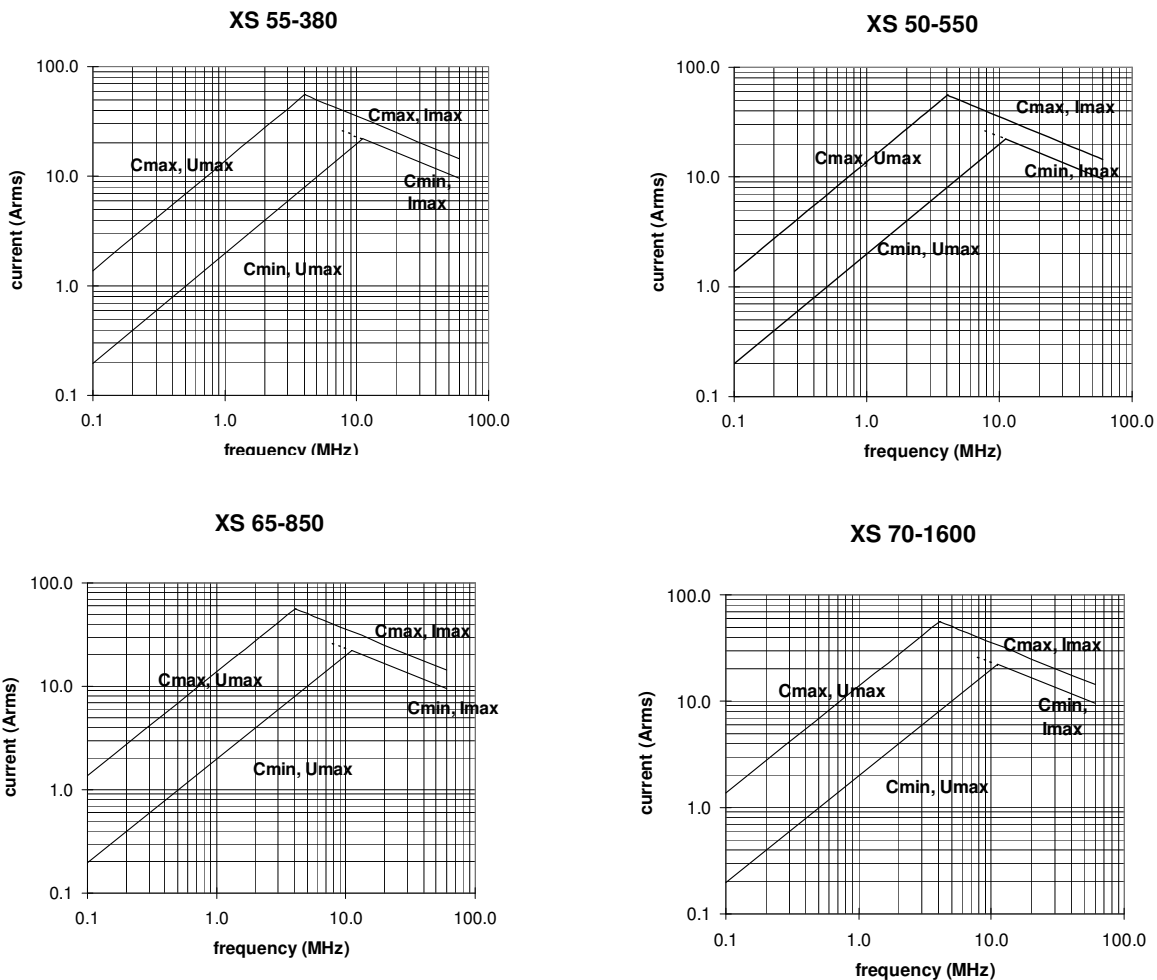

Above figures were measured without any forced cooling. To increase current capabilities at higher frequencies it is suggested to cool the connecting plate of the X-CAP™ by adding a cooling flange for forced air- or water cooling. It is also very helpful to cool the capacitor housing by means of an air blower.

6. Life Tests

Several life tests were carried out showing that 250'000 cycles can be reached without exceeding the specified torque value. As good engineering practice and for regreasing the connecting elements, it is suggested to rotate the tuning shaft regularly every 5 - 10 thousand cycles several turns in both directions.

The connecting elements between variable electrodes and the external connecting plate have been tested already earlier. Over 1'000'000 cycles could be performed without significant traces of usage.

Experiments concerning the integrity of the retaining ring, responsible for assuring the internal gas pressure, show a leak rate of some 10^{-8} mbar·l/s under operating conditions (cycles), corresponding to over 5 years of safe operation.

7. Comparison: X-CAP™ SlimLine vs. Standard Air Capacitors

Compared to air capacitors, the X-CAP™ is hermetically closed in a metal housing preventing the electrodes, contacts and bearings from contamination by dust and moisture.

While the terminals of air capacitors are mostly simple screws with a diameter of about 4 mm, the X-CAP™ has a large silver plated contact area, allowing the integration into the electronic circuit with very low line inductivity and/or ohmic loss.

Thanks to the used gas dielectric, X-CAP™ uses only 50% of the volume of comparable air capacitors (same voltage capability, same capacitance), which leads also to lower internal stray inductance.

A special multiple connecting concepts assures absolutely low loss connection between variable electrodes and connecting plates even after many hundred thousand cycles.

As already mentioned under 5.2 the Q-factor is inversely proportional to the resistivity of the capacitor. The very low resistivity of the X-CAP™ leads therefore to excellent Q-factors which are more than 2 times better than those of commonly used air capacitors.

8. Labeling and Packing of X-CAP™ SlimLine

X-CAP™ is sealed in a robust transparent plastic bag and then mechanically protected in an especially designed cardboard box of 85 x 155 x 300 mm³. It guarantees a high degree of protection against environmental influences like shock, dirt The packing is convenient for shipping and storage purpose. The COMET part number of the capacitor is printed on 3 sides of the box.

In addition a 30 mm x 40 mm label - identical to the one on the X-CAP™ - is placed to the front side of each box to identify its contents and to provide the following information:

- manufacturer's name
- version of X-CAP™
- serial number

- origin of product

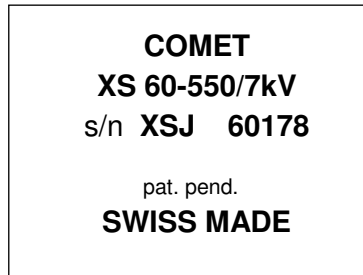

9. Application Notes

9.1 Mounting

As already mentioned under point 3 (technical data), all 4 mounting threads of the insulator have to be used in order to prevent the ladder from destruction. While molding the insulators, the nuts are inserted simultaneously. Under influence of the applied high frequency voltage, eddy currents may flow to the insulated metal parts and heat up the insulator material. Excessive temperatures will then destroy the capacitor.

9.2 Forces On Driving Shaft

When connecting the driving shaft of X-CAP™ to a motorized steering unit, be sure to avoid sideload. This is essential in order to assure extended life cycle.

X-Cap™ K-types are equipped with a ball bearing accepting a static side load of up to 50N. This version is therefore recommended when the capacitor is driven by means of tooth wheels or tooth belts.

10. Replacing Air Capacitors with X-Caps™ SlimLine

As mentioned already earlier, one target of the X-Cap™ SlimLine series is to allow easy replacement of air capacitors in order to enhance the application's overall power capability without major design changes. COMET TECHNIK AG has therefore chosen an outer diameter for the X-Cap™ SlimLine family which is even smaller than commonly used equivalent air cap devices. The 3 figures below compare the cross sections of the X-Cap SlimLine with the ceramic insulator of current brand names.

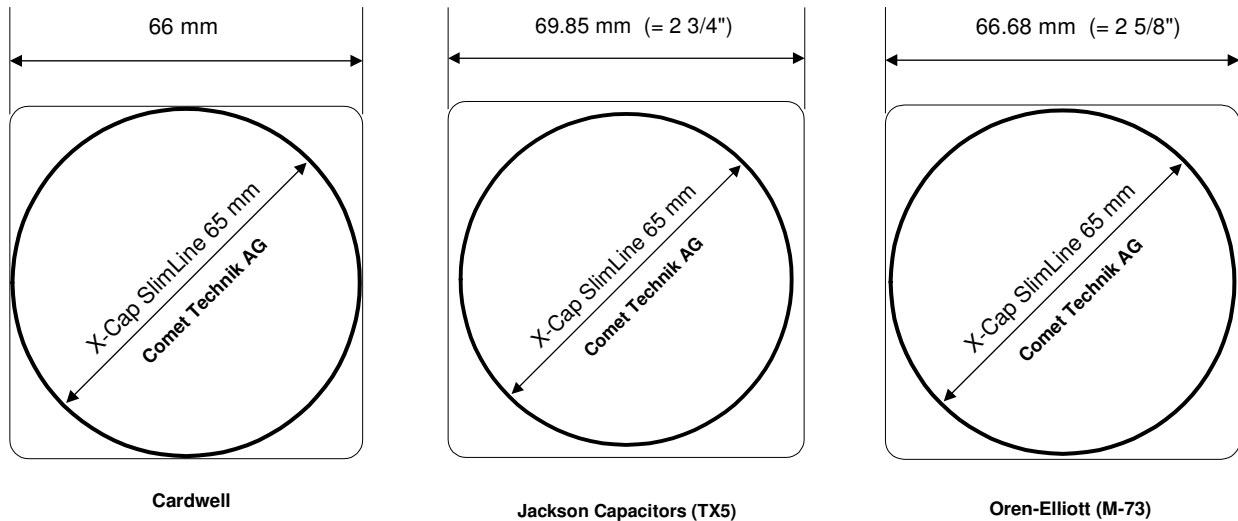

11. Gas dielectric SF₆

11.1 Characteristics

- inert, non corrosive gas
- nontoxic (inhalation of decomposition products should be avoided when high electrical sparking occurs)
- not flammable in air
- dielectric strength, dielectric constant ϵ_r independent of frequency
- thermal stability up to 800 °C
- low electrical loss factor ($\tan \delta \approx 2 \cdot 10^{-7}$)
- density (6.60 kg/m³) is 5 times higher than air (1.29 kg/m³)
- thermal conductivity is 5 times higher than air (0.0026 W/(m·K))

11.2 Pressure Integrity

The X-CAP™ housing is designed to keep the initial gas pressure of 3 bars at a level which guarantees the electrical specifications for years. A series of tests have been performed in order to assure minimum pressure for safe operation. It has been found, that even at 1.5 bars (half of initial pressure) the test voltage is close or identical to the specified value. The time for pressure drop of 1 bar under operating conditions can exceed 5 years but depends on the cycle frequency.