

CVDU-1000BC/3-BAF-U

Old Type Designation: CV03C-1000P

Specifications

Capacity C_{max} (nominal)	1000 pF
Capacity C_{min} (nominal)	8 pF
Voltage (Peak Test U_{pt} / Peak Working U_{pw})	3 kV / 1.8 kV
Capacity Tolerance (linear Range)	10%
Max. Current I_{max} at 13.56 MHz with	65 Arms
Conduction Cooling	20 W
Self Inductance	≤ 8 nH
Capacitance per turn	125.9 pF/turn
Torque	≤ 0.2 Nm
Net Weight	0.4 kg

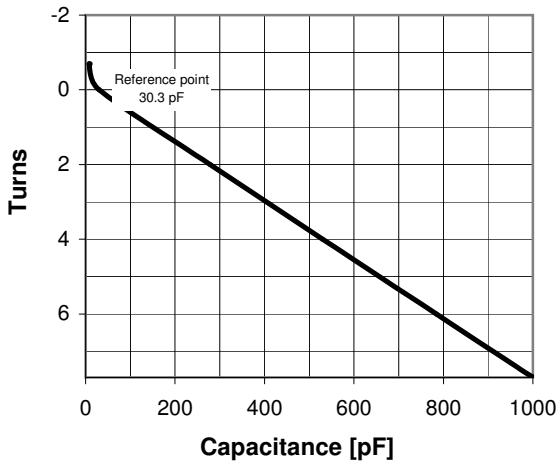
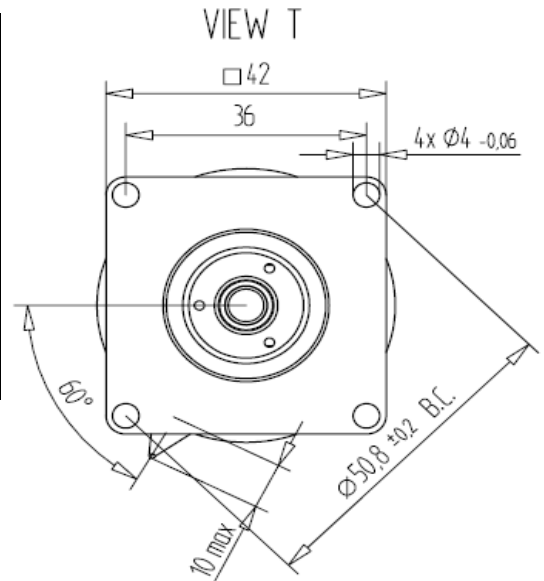

I_{max} at 25°C ambient and 125°C surface temp. for convection and conduction (20 W) cooling

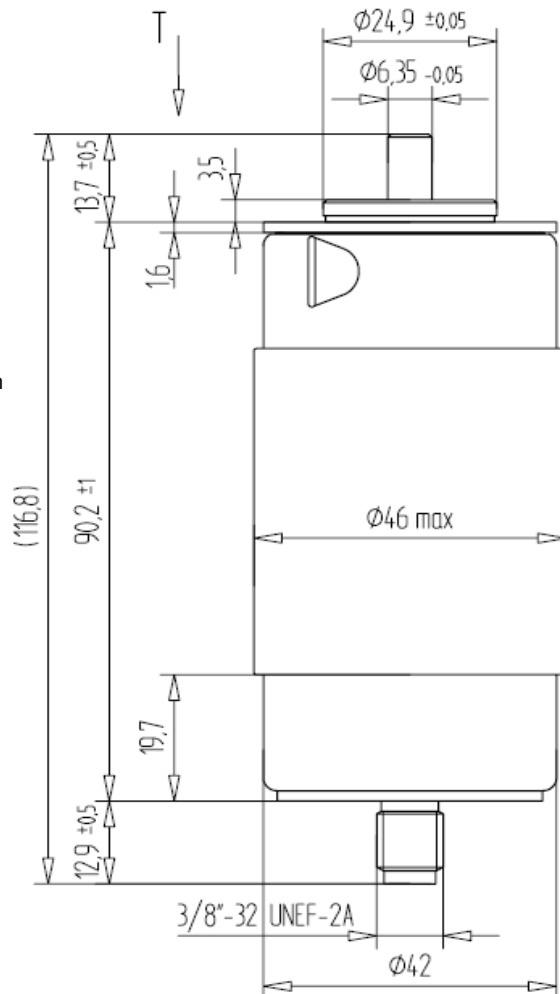
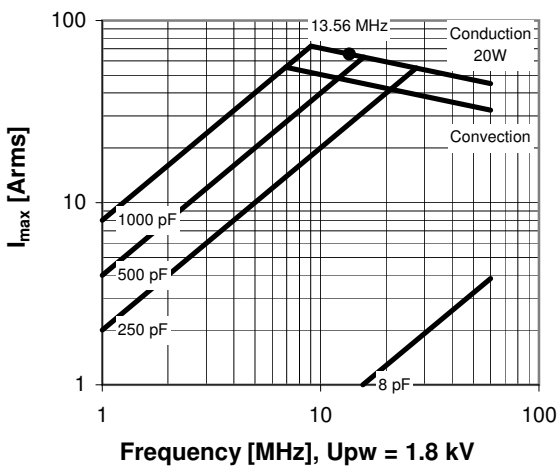

Subject to change without prior notice

Note: Technical information in Service Bulletin SB-52 must be considered

Turns	Nominal Capacitance [pF]	Tolerance
-0.7	8.0	10%
0.0	30.3	0%
2.0	278.3	10%
4.0	530.0	10%
6.0	784.6	10%
7.7	1000.0	10%

Mechanical stop at < 8 pF at ~ -2.3 turns
 Mechanical stop and short circuit at > 1000 pF

Self inductance and resonance frequency

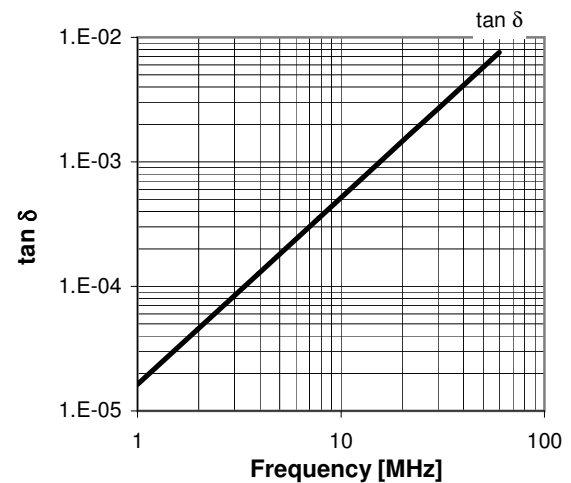
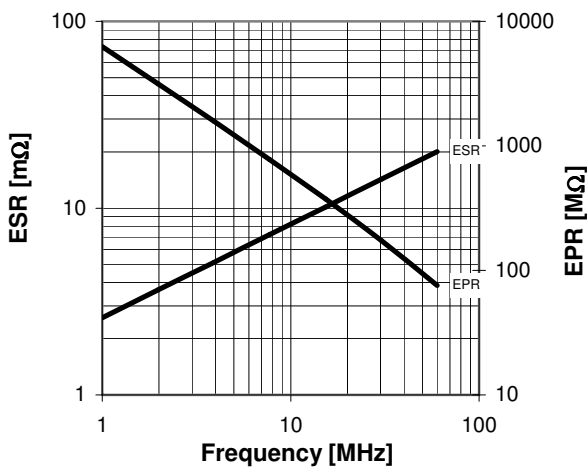
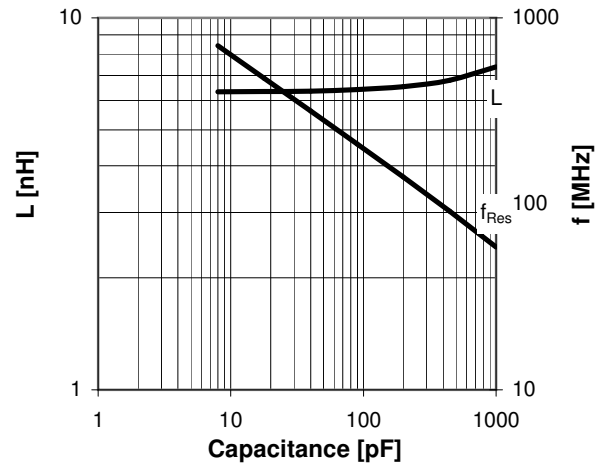

Special Features:

Short-Circuit-Feature

Subject to change without prior notice

Note: Technical information in Service Bulletin
 SB-52 must be considered