

CVVI-1000AC/5-ACD-M

Old Type Designation: CV05C-1000X

Specifications

Capacity C_{max} (nominal)	1000 pF
Capacity C_{min} (nominal)	7 pF
Voltage (Peak Test U_{pt} / Peak Working U_{pw})	5 kV / 3 kV
Capacity Tolerance (linear Range)	10%
Max. Current I_{max} at 13.56 MHz with	80 Arms
Conduction Cooling	30 W
Self Inductance	≤ 9 nH
Capacitance per turn	78.3 pF/turn
Torque	≤ 0.3 Nm
Net Weight	1.2 kg
Mounting Flange (optional)	058-010/030

VIEW S

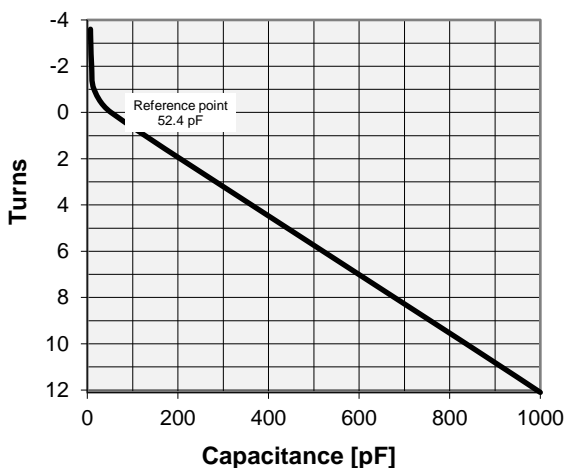
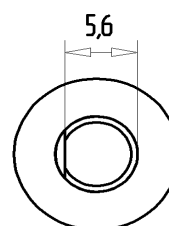

I_{max} at 25°C ambient and 125°C surface temp. for convection and conduction (30 W) cooling

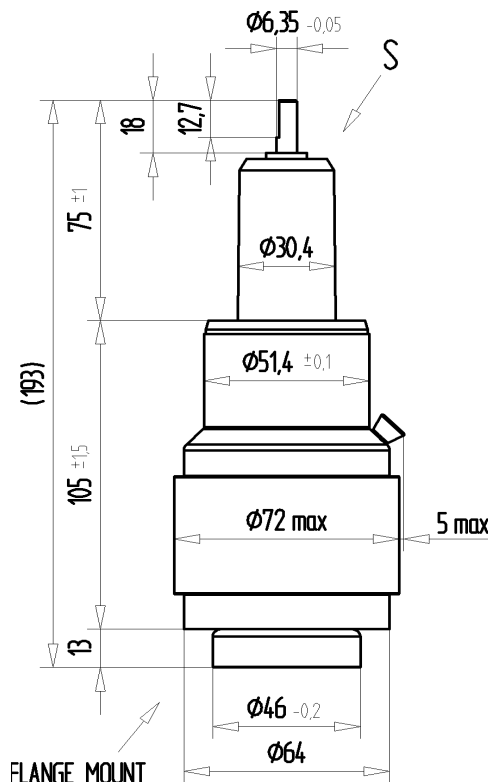
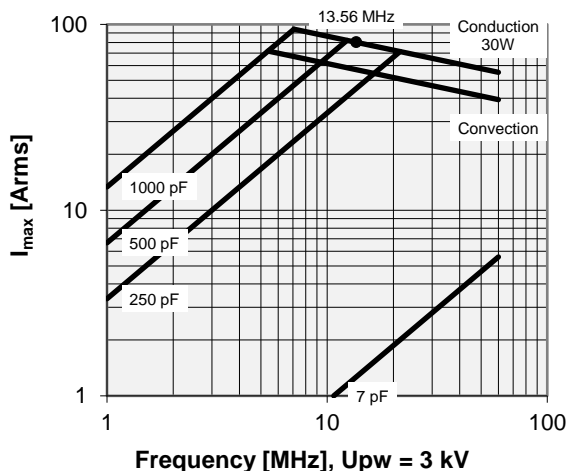

Note:

Technical information in Service Bulletin SB-52 must be considered
Subject to change without prior notice

Issue: 19-Apr-2006
Replaces: 22-Aug-2001

CVVI-1000AC/5-ACD-M

Old Type Designation: CV05C-1000X

Turns	Nominal Capacitance [pF]	Tolerance
-3.6	7.0	10%
-3.0	7.7	10%
-2.0	9.6	10%
-1.0	14.9	10%
0.0	52.4	0%
5.0	441.6	10%
10.0	836.3	10%
12.1	1000.0	10%

Mechanical stop at < 7 pF at ~ -10.8 turns
 Mechanical stop at > 1000 pF at ~ 12.3 turns

Self inductance and resonance frequency

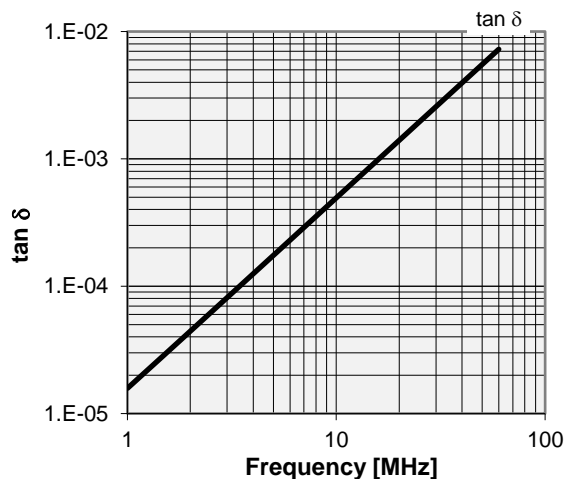
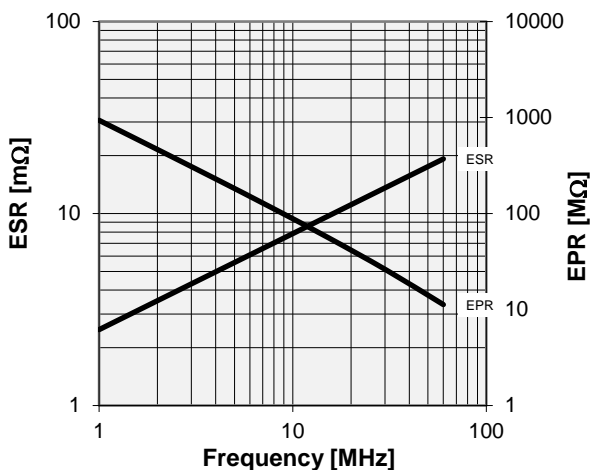
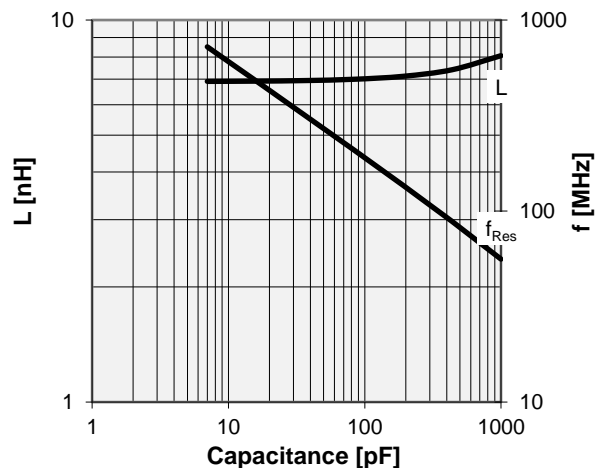

Special Features:
Flange-Mount

Note:
 Technical information in Service Bulletin
 SB-52 must be considered
 Subject to change without prior notice